

CellBridge LTE310SMT v1.00 World Wide CAT-M1/NB-IoT User Manual

CellBridge™
Global Cellular Modem Solutions

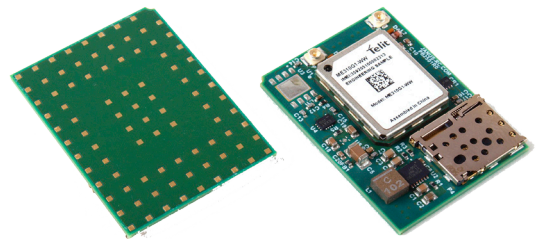

JANUS REMOTE
C ● M M U N I C A T I O N S ●

Bulletin	JA24UM-LTE310SMT v1
Revision	03
Date	07 March 2023

TABLE OF CONTENTS

TABLE OF CONTENTS and DISCLAIMER	2
1 APPLICABILITY TABLE	3
2 REFERENCES	3
2.1 Janus Document List.....	3
2.2 Telit Document List.....	3
3 OVERVIEW	4-6
3.1 Introduction	4
3.2 Preview	4
3.3 Features.....	5
3.4 Block Diagram.....	5
3.5 FOTA Notice	6
4 INTERFACES.....	7-13
4.1 Antenna Connectors.....	7
4.2 SIM Holder	7
4.3 LGA Signals.....	8-13
5 LTE310SMT TECHNICAL SPECIFICATIONS	14-17
5.1 Electrical Specifications	14-16
5.2 Mechanical Drawings.....	17
6 OPERATION	18-22
6.1 Powering ON/OFF	18
6.2 Communicating with the Modem	18
6.3 Testing Communications.....	18
6.4 Cellular Network Communications.....	19-20
6.5 Data Communications.....	20-21
6.6 SMS.....	21
6.7 GNSS.....	21
6.8 Firmware Selection.....	22
7 DESIGN CONSIDERATIONS.....	22
7.1 Minimum required Modem Pin-Connection	22
7.2 Debug.....	22
APPENDICES.....	23-24
Approvals	23
Antenna Care and Replacement	23
Abbreviations.....	23
Ordering Information	24
Revision History.....	24

DISCLAIMER

The information contained in this document is the proprietary information of Connor-Winfield Corporation and its affiliates (Janus Remote Communication). The contents are confidential and any disclosure to persons other than the officers, employees, agents or subcontractors of the owner or licensee of this document, without the prior written consent of Connor-Winfield, is strictly prohibited. Connor-Winfield makes every effort to ensure the quality of the information it makes available. Notwithstanding the foregoing, Connor-Winfield does not make any warranty as to the information contained herein, and does not accept any liability for any injury, loss or damage of any kind incurred by use of or reliance upon the information. Connor-Winfield disclaims any and all responsibility for the application of the devices characterized in this document, and notes that the application of the device must comply with the safety standards of the applicable country, and where applicable, with the relevant wiring rules. Connor-Winfield reserves the right to make modifications, additions and deletions to this document due to typographical errors, inaccurate information, or improvements to programs and/or equipment at any time and without notice. Such changes will, nevertheless be incorporated into new editions of this application note.

All rights reserved 2020 Connor-Winfield Corporation

1 APPLICABILITY TABLE

Product	Part Number
LTE310SMT	v1.00

2 REFERENCES

2.1 Janus Document List

Janus Application Note 117 - FOTA (Firmware Over The Air)

2.2 Telit Document List

Our modem uses Telit ME310G1-WW cellular module.

Please refer to Telit's website at www.telit.com for the latest information on the ME310G1 module family.

Telit ME310G1/ME910G1/ML865G1 AT Commands Reference Guide

Telit ME310G1 Hardware Design Guide

Telit ME310G1/ME910G1/ML865G1 PSM Application Note

Telit MEx10G1 GNSS Application Note

Telit IP Easy User Guide

Telit Single SKU AT Command Application Note

Telit ME910C1/MEx10G1 Quick Start Guide [a.k.a. Telit Cat M/NB-IoT Quick Start Guide]

3 OVERVIEW

3.1 Introduction

The User Manual for the SMT footprint Modem devices is intended to illustrate how users can integrate and implement the features of each communication version of the device. The common factors are explained in detail, as well as special considerations and diagrams for the Modem. The Modem differences are highlighted in this manual for design considerations for future model placement.

3.2 Preview

The SMT footprint Modems are self-contained, multi-band, globally capable, IoT and M2M communication devices designed to provide a comprehensive solution to application problems for our customers. They utilize the proven technology of Telit's certified modules for their core communications engines.

3.2.1 Functional Description

Cellular

- LTE Cat.M1 / NB IoT

GNSS Functionality

- GPS, GLONASS, Beidou, Galileo and QZSS

UART

- 115200 bps default supporting up to 6 standard RS232 signals

USB

- HS/FS USB 2.0 Device (480Mb/s)

Physical Dimensions

- Length and width of all devices are equal
- Heights of different devices will vary

3 OVERVIEW continued

3.3 Features

- Multi-Band Support
- LTE (4G) Bands: B1, B2, B3, B4, B5, B8, B12, B13, B18, B19, B20, B25, B26, B27, B28, B66, B71, B85
- GSM (2G) Bands: B2, B3, B5, B8
- LTE Output Power: 23dBm (Power Class 3)
- GSM Output Power: 33dBm (Power Class 4)
- LTE: DL: Up to 588 kbps, UL up to 1Mbps
- GNSS (Global Navigation Satellite System) includes GPS, GLONASS, Beidou and Galileo
- Control via standard and extended AT command set
- SIM application Tool Kits 3GPP TS 51.01
- IP stack with TCP/UDP protocol support
- SMS Support
- 89 pad LGA module
- Dimensions: 35 mm x 26 mm x 3.56 mm
- Operational Temperature Range: -40°C to 85°C
- Internal Switching Regulator:
 - Input Voltage Range: 2.5 to 5.25Vdc (5Vdc nominal)
 - Supply disable via terminal input pin
- Cellular and GNSS antenna connections via Hirose U.FL miniature RF connectors

3.4 Block Diagram

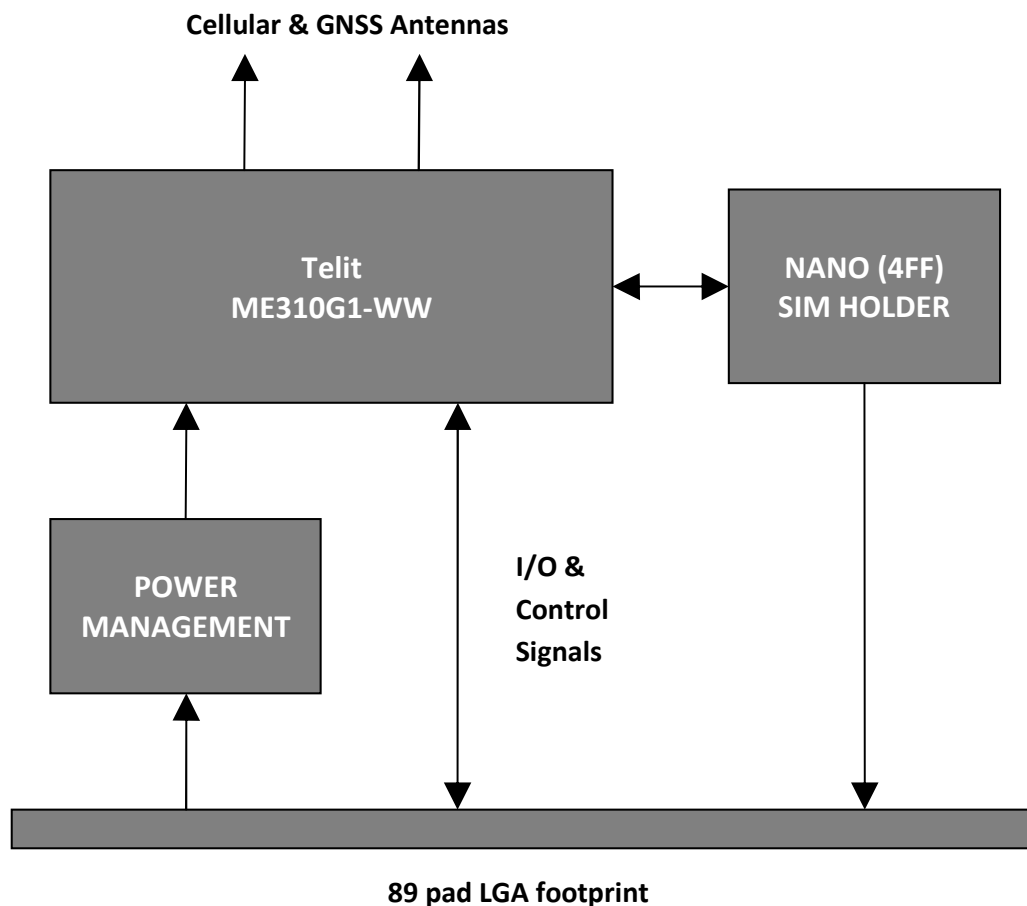

Figure 1 LTE310SMT v1.00 Block Diagram

3 OVERVIEW continued

3.5 FOTA Notice

The certification of LTE devices for use on the Verizon Wireless network REQUIRES that the end user implement an automated FOTA procedure on their devices that would allow the cellular module firmware to be updated if required.

Failure to implement an automated FOTA procedure violates the certification requirements of the cellular modem and may result in units becoming unusable on the cellular network in the future. Your end device must support the firmware over the air update for the cellular modem

You may use your own FOTA system to update the cellular modem firmware over the air. You may also be able to use the Verizon Wireless FOTA system, and FOTA services may be available from other 3rd party vendors.

To inquire about Verizon Wireless FOTA system information and technical specifications, contact VZW.FOTA-Services@VerizonWireless.com

4 INTERFACES

The top side of the LTE310SMT provides cellular and GNSS antenna connections and a SIM card holder. All power and signal connections are made through the LGA footprint.

4.1 Antenna Connectors

Two U.FL connectors provide antenna connections for the cellular antenna and the GNSS antenna. The GNSS antenna is provided with a 3.3V bias supply for LNA (low noise amplifiers) typically found in GPS antennas. This bias supply is only active when the module GNSS feature is turned on.

4.2 SIM Holder

A 'push-push' (push to lock, push to release) on-board nano (4FF) SIM card holder is provided. The SIMSEL signal must be tied low in order to utilize the SIM holder. All SIM signals from the ME310G1 module connect to the SIM holder. The SIM holder card presence switch is connected to the SIMSEL LGA pad.

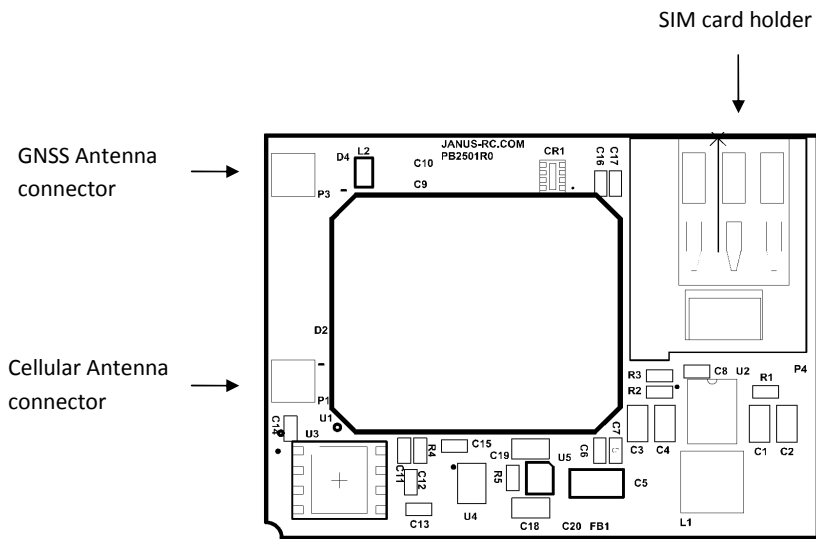

Figure 2 LTE310SMT Top - SIM Holder

4 Interfaces continued

4.3 LGA Signals

Most of the LGA signals on the LTE310SMT module are direct connections to corresponding signals on the ME310G1-WW cellular module. See the Telit ME310G1 Hardware Design Guide for complete information on these signals.

A few ME310G1 signals, including VBATT (power input) GPS_LNA, and the SIM card interface signals are not directly available but are utilized in the on-board circuitry.

Almost all digital signals operate at a 1.8V CMOS level. Output drive capability is typically 1 mA

4.3.1 LGA Pad Signal Table

Pad	Signal	I/O	Function	Type	Telit ME310G1 Pad	Notes
Asynchronous Serial Port (USIF0) [Note 1]						
H8	TXD0	I	Transmit line	CMOS 1.8V	Y16	2
H9	RXD0	O	Receive line	CMOS 1.8V	AA15	
I9	CTS0	O	Clear to Send	CMOS 1.8V	AA17	
I8	RTS0	I	Request to Send	CMOS 1.8V	Y18	2
Asynchronous Serial Port (USIF1)						
H10	TXD1	I	Transmit line	CMOS 1.8V	Y12	2
H11	RXD1	O	Receive line	CMOS 1.8V	AA11	3
I10	CTS1	O	Clear to Send	CMOS 1.8V	Y14	
I11	RTS1	I	Request to Send	CMOS 1.8V	AA13	2
Auxiliary Serial Port						
I12	TX_AUX	O	Auxiliary UART output data line	CMOS 1.8V	Y10	
H12	RX_AUX	I	Auxiliary UART input data line	CMOS 1.8V	AA9	2
USB HS 2.0 Communication Port						
I6	USB_D_P	I/O	USB differential Data (+)	USB data	U19	
I7	USB_D_N	I/O	USB differential Data (-)	USB data	V18	
H6	USB_VBUS	I	USB Power Sense	5.25v max	T18	
SPI						
F11	SPI_CS	I/O	SPI_CS I/O SPI Chip Select	CMOS 1.8V	Y6	
F12	SPI_CLK	I/O	SPI_CLK I/O SPI Clock	CMOS 1.8V	AA7	
G11	SPI_MISO	I/O	SPI_MISO I/O SPI MISO	CMOS 1.8V	Y8	
G12	SPI_MOSI	I/O	SPI_MOSI I/O SPI MOSI	CMOS 1.8V	AA5	
DIGITAL IO						
C1	GPIO_01	I/O	General Purpose I/O	CMOS 1.8V	V11	4, 5
C2	GPIO_02	I/O	General Purpose I/O	CMOS 1.8V	V13	4
C3	GPIO_03	I/O	General Purpose I/O	CMOS 1.8V	D7	4
D1	GPIO_04	I/O	General Purpose I/O	CMOS 1.8V	D9	4
D2	GPIO_05	I/O	General Purpose I/O	CMOS 1.8V	D11	4
E2	GPIO_06	I/O	General Purpose I/O	CMOS 1.8V	D13	4
ADC and DAC						
G3	ADC	I	ADC Converter	CMOS 1.8V	B18	
H5	DAC	O	DAC Converter	CMOS 1.8V	R16	6
SIM						
A6	SIMSEL	I	SIM select - tie to GND for SIM holder	CMOS 1.8V	---	
A7	CARD_DET	O	SIM holder switch contact. Connects to GND when card is present.	---	---	
Audio Section						
A2	DVI_CLK	I/O	Digital Audio Interface (BCLK)	CMOS 1.8V	F2	
A3	DVI_TX	O	Digital Audio Interface (TX)	CMOS 1.8V	E1	
B1	DVI_RX	I	Digital Audio Interface (RX)	CMOS 1.8V	D2	
B2	DVI_WA0	I/O	Digital Audio Interface (Word Alignment /LRCLK)	CMOS 1.8V	C1	

4 Interfaces continued

4.3 LGA Signals continued

4.3.1 LGA Pad Signal Table continued

Pad	Signal	I/O	Function	Type	Telit ME310G1 Pad	Notes
Control & Indications						
I5	ON_OFF	I	Input Command for Power ON/OFF, wake from deep sleep, and unconditional reset.	CMOS 1.8V	N16	7
B5	PWRMON	O	Power ON Monitor	CMOS 1.8V	R1	
D3	S_LED	O	Status LED	CMOS 1.8V	B2	
H4	GPS_PPS	O	1 Pulse per Second	CMOS 1.8V	G16	
B6	USB_BOOT	I	Optional pin, connect to test point	CMOS 1.8V	T2	4, 8
Power Supply						
C11, C12, D11, D12	VIN		Main power supply	POWER	---	
A8, A11, A12, B3, B11, B12, D5, D6, D7, D8, E1, E5, E6, E7, E8, E12, F5, F6, F7, F8, G10, H3, H7	GND		Ground	POWER	A3, A7, A9, A13, A17, B4, B6, B10, B12, B14, B16, C19, D18, F8, F12, F18, G19, H6, H14, J19, K18, M18, N19, P6, P14, T8, T12, U1, V2, W19, Y2, Y4	
A10	PG		Power good output from on-board regulator. High output indicates power good. Pull high; 7.0V absolute maximum. Can be left open.	OPEN DRAIN	---	
B7	CTANK		Internal supply domain pin for external tank capacitor	1.8V	N4	
B10	ENABLE		On-board power supply enable. Pulled up to VIN via 200K ohm. Pull LOW to disable supply.	VIN	---	
RESERVED [Note 9]						
A4	RSVD_H2		RESERVED	Do not connect	H2	10, 11
A5	RSVD_J1		RESERVED	Do not connect	J1	10, 11
A9	RSVD_V9		RESERVED	Do not connect	V3	10
B4	RSVD_G4		RESERVED	Do not connect	G4	10
B8	RSVD_R4		RESERVED	Do not connect	R4	10
B9	RSVD_L4		RESERVED	Do not connect	L4	10
E3	RSVD_B8		RESERVED	Do not connect	B8	10
E10	RSVD_V7		RESERVED	Do not connect	V7	10
F1	RSVD_J16		RESERVED	Do not connect	J16	10
F2	RSVD_J4		RESERVED	Do not connect	J4	10
F3	RSVD_K2		RESERVED	Do not connect	K2	10
F10	RSVD_R19		RESERVED	Do not connect	R19	10
G2	RSVD_G1		RESERVED	Do not connect	G1	10, 11
H2	RSVD_P18		RESERVED	Do not connect	P18	10
I4	RSVD_L16		RESERVED	Do not connect	L16	10
UNCONNECTED						
C10, D10, E11, G1, H1, I1, I2, I3	---		Unconnected pad	Do not connect	---	---

NOTES

1. DTR and RING signals are available as alternate GPIO functions.
2. Internal 100K ohm pull-up.
3. Must be "LOW" at boot.
4. Internal 100K ohm pull-down. GPIO pads support alternate functions; see the Telit ME310G1/ME910G1/ML865G1 AT Commands Reference Guide.
5. Internal 100K ohm pull-up if configured as DTR.
6. PWM signal.
7. Active low.
8. Active high.
9. ME310G1 Reserved Pads A11, A15, and L19 are not supported.
10. Reserved pins must not be connected.
11. The MIPI antenna tuner interface available on Telit ME310G1 HW 1.0 modules is not supported.

4 Interfaces continued

4.3 LGA Signals continued

4.3.2 LGA Pad Arrangement

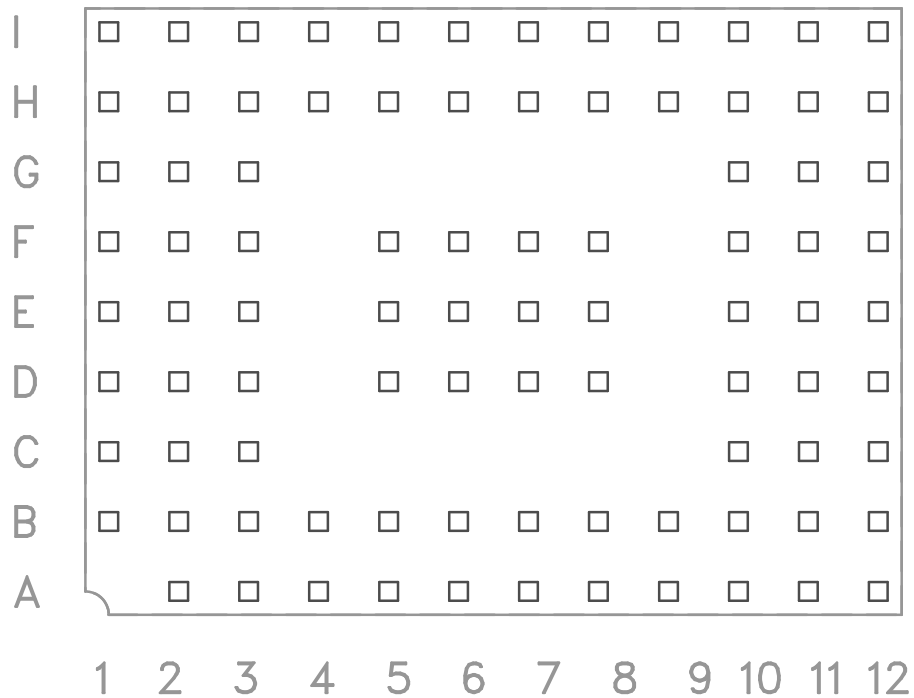

Figure 3 Pad Numbers Top View

4.3.3 LGA Signal Description

4.3.3.1 UARTs

Three UART interfaces are provided:

1. USIF0: Primary UART. Can be used as AT Command port and can provide GNSS NMEA stream output. It is supported by dedicated TXD, RXD, CTS and RTS signals. DTR and RING signals can be optionally provided by GPIO signals. Default baud rate is 115200 bps.
2. USIF1: Secondary UART. Can be used as AT Command port and can provide GNSS NMEA stream output. It is supported by dedicated TXD and RXD signals.
Note that this UART is not supported in the current firmware release at the time of this writing.
3. AUX UART: Can be used as an AT command port, and can be used for diagnostic monitoring and debugging (per the Telit ME310G1 Hardware Design Guide).
Note that all UART signals are 1.8 V CMOS. Level translation is usually required for application interfaces. UART communication parameters are 15200 baud 8N1 by default.

4 Interfaces continued

4.3.3 LGA Signals Description continued

4.3.3.2 USB

A USB 2.0 HS interface that can instantiate multiple interfaces on a host device, including modem, COM (serial) and network (WWAN) connections. In addition to providing command and data functions, you must implement the USB interface to provide the ability to locally update module firmware.

In order for proper power-up of the Modems, the USB_VBUS line **MUST** be disconnected until the unit is otherwise fully powered and on. If the USB_VBUS line is attached and powered before the main power is brought up and the Modem turned on, power sequencing issues may occur.

Below is a suggested interface that implements a VBUS_ENABLE signal in order to control the USB connection to the module.

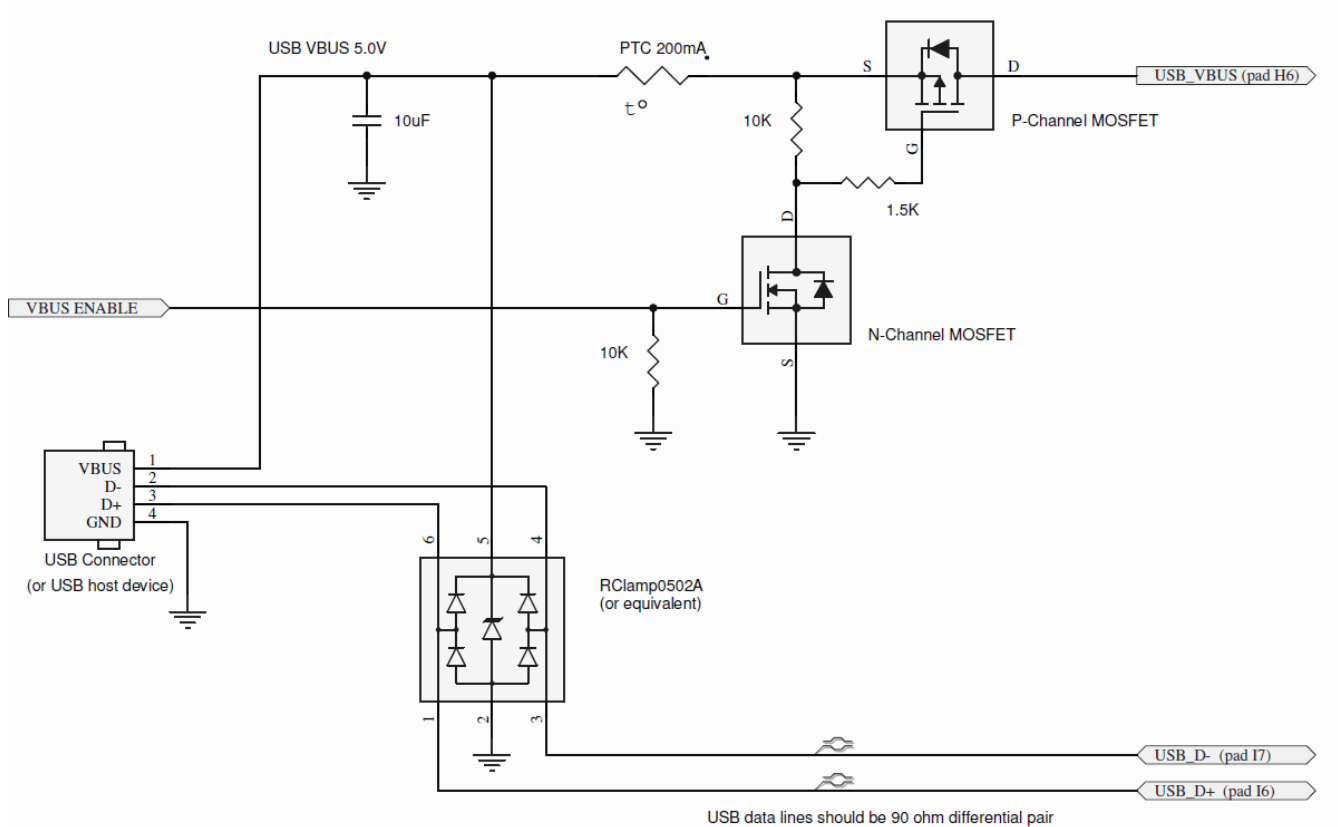

Figure 4 USB Connection

4 Interfaces continued

4.3.3 LGA Signals Description continued

4.3.3.3 GPIO

GPIO are configurable as input, output, and alternate function. Configuration is controlled by AT commands. Alternate functions include an ALARM pin function, temperature monitor indication, and the FASTSHDN feature. See the AT Commands Guide for more information.

Using a GPIO Pin as INPUT

The GPIO pins, when used as inputs, can be connected to a digital output of another device and report its status, provided this device has interface levels compatible with the voltage levels of the GPIO of the modem.

Using a GPIO Pin as OUTPUT

The GPIO pins, when used as outputs, can drive CMOS digital devices or compatible hardware. When set as outputs the pins have a push-pull output.

4.3.3.4 SPI

The SPI interface provides a 3-wire master or slave SPI interface with chip select control. It can be used as an AT Command port.

4.3.3.5 ADC

An Analog-to-digital input provides a 0-1.8 volt output reading with a resolution of 10 bits.

4.3.3.6 DAC

An digital PWM output that can be filtered and used as a 0 to 1.8 volt analog output.

4.3.3.7 SIM

The ME310G1 SIM interface signals connect to the nano (4FF) SIM holder on the LTE310SMT board. The following two signals supplement it's use:

SEMSEL:

SIM Select signal. This signal must be tied to ground to enable the on-board SIM holder.

CARD_DET:

Card Detect switch. This connects to the card presence switch in the SIM card holder.

SIM status	CARD_DET signal
SIM present	connected to ground
SIM not present	open circuit

4.3.3.8 DVI Audio

An audio interface based on the I2S serial bus interface standard is provided. The audio port can be connected to end device using digital interface, or converted to analog using a compatible CODEC.

Note that the DVI function is not supported in the current firmware release at the time of this writing.

4.3.3.9 Control & Indicators

ON_OFF Signal

The ON_OFF signal is used to turn the module on and off. It can also be used as an unconditional shutdown control. This signal must only be driven with an open-collector / open-drain type driver.



Figure 5 ON / OFF Driver

4 Interfaces continued

4.3.3 LGA Signals Description continued

4.3.3.9 Control & Indicators continued

PWRMON

The PWRMON signal is asserted to indicate that the Telit ME310G1 is on and operating. This signal operates at 1.8 V and has a 1 mA drive capability. It can be used to sense when the module is ON, and can be used as the 1.* V reference for external translators as long as the current capability is not exceeded.

Note that this signal will go low when the module is operating in the PSM (Power Saving Mode) on Cat.M1 and Cat.NB-IoT cellular networks.

S_LED Cellular Status LED

The S_LED output signal is used to drive an external LED to give feedback on the current network registration status. The behavior of this signal is determined by the AT#SLED command.

See the Telit ME310G1/ME910G1/ML865G1 AT Commands Reference Guide for more information.

GPS_PPM

Note that this function is not supported in the current firmware release at the time of this writing.

USB_BOOT

This pin should be made available via a test pin connection. Per the Telit ME310G1 Hardware Design Guide:

“In some case of firmware upgrade FORCED_USB_BOOT pin must be set to 1.8V during poweron of ME310G1.”

4.3.3.10 Power

VIN

VIN is the main supply to the on-board switching supply. It is capable of accepting between 2.5 v and 5.25 volts.

ENABLE

This is an enable signal to the on-board switching power supply. It is normally tied to VIN via a 200K ohm resistor. To disable the on-board supply, pull this signal to ground.

CTANK

This signal provides a connection to the internal supply of the ME310G1. It can be used to additional capacitance for enhanced power loss recovering and as a pull-up in specific use cases. See the Telit ME310G1 Hardware Design Guide.

4.3.3.11 Reserved pads

A number of signal pads have been designated for future use by Telit. Most of these pads are brought out to the LGA footprint to support future use. All 'RESERVED' pads should be left unconnected.

Note: ME310G1 Reserved Pads A11, A15, and L19 are not supported

5 LTE310SMT TECHNICAL SPECIFICATIONS

5.1 Electrical Specification

5.1.1 Absolute Maximum Ratings

Parameter	Min	Typ	Max	Unit	Note
Input on ant 1.8 VCMOS Signal	-0.3	-	2.1	Volt	
Storage Temperature	-40	-	85	°C	
Moisture Sensitivity	-	Level 3	-		
VIN Supply Voltage	0	-	7.0	Volt	

Operation of the device at these or any other conditions beyond those listed under Recommended Operating Conditions is not implied. Exposure to Absolute Maximum Rating conditions for extended periods of time may affect device reliability.

5.1.2 Recommended Operating Conditions

Parameter	Min	Typ	Max	Unit	Note
Temperature	-40	-	85	°C	
VIN Supply Voltage	2.5	5.0	5.25	Volt	
GNSS Antenna Bias Voltage (P3)	-	3.3	-	Volt	1

Note: 1. Bias voltage only available when GNSS is enabled.

5.1.3 Power Consumption ^{1, 2, 3}

Mode	Average (mA)	Peak (mA)	Mode Description
Switched Off			
Module Off; power ENABLE open (ON)	0.05		Module supplied but switched
Module OFF; power ENABLE low (OFF)	0.025		On-board power supply disabled
Mode	Average (mA)	Peak (mA)	Mode Description
IDLE MODE			
	CATM (mA)	NBLoT (mA)	2G (mA)
AT+CFUN=1	8.1	7.8	7.6
AT+CFUN=4		6.4	
AT+CFUN=5	1	0.83	
AT+CFUN=5	0.53	0.53	
AT+CFUN=5	0.18	0.18	
AT+CFUN=5	0.11	0.11	
AT+CFUN=5	0.07	0.07	
AT+CFUN=5	0.05	0.05	
AT+CFUN=5			0.79
PSM MODE			
AT+CPSMS=1	0.05	0.05	N/A
CONNECTED MODE			
CATM	320		930
CATM	270		760
CATM	258		680
NBLoT		200	280
NBLoT		510	840
NBLoT		420	720
NBLoT		360	630
NBLoT		57	250
NBLoT		74	800
NBLoT		66	680
NBLoT		65	620
GPRS			250
GPRS			1700
GPRS			140
GPRS			840

Note 1: These figures are derived from the component data sheets including the Telit ME310G1 Hardware Design Guide. Per Telit, "The reported values are an average among all the product variants and bands for each network wireless technology." Results can vary depending network conditions.

Note 2: Values are calculated based on 5.0 volt supply voltage and on-board power supply efficiency.

Note 3: Values do not include GNSS operation or GNSS antenna bias requirements.

5 LTE310SMT TECHNICAL SPECIFICATIONS continued

5.1 Electrical Specification continued

5.1.4 I/O Levels

The following signal functions are direct connections to the Telit ME310G1 module. For specific electrical characteristics see the Telit ME310G1 Hardware Design Guide:

UARTS

USB

SPI

GPIO

ADC

DAC

DVI audio

ON_OFF

PWRMON

S_LED

GPS_PPS

USB_BOOT

CTANK

5 LTE310SMT TECHNICAL SPECIFICATIONS continued

5.1 Electrical Specification continued

5.1.5 LTE Cellular Antenna Specifications:

Parameter	Description
Frequency Range	Depending on frequency bands provided by the network operator, the customer should use the most suitable antenna for those frequencies.
Bandwidth	250 MHz in LTE Band 1 140 MHz in LTE Band 2, PCS1900 170 MHz in LTE Band 3, DCS1800 445 MHz in LTE Band 4 70 MHz in LTE Band 5, GSM850 80 MHz in LTE Band 8, GSM900 47 MHz in LTE Band 12 41 MHz in LTE Band 13 60 MHz in LTE Band 18 60 MHz in LTE Band 19 71 MHz in LTE Band 20 145 MHz in LTE Band 25 80 MHz in LTE Band 26 62 MHz in LTE Band 27 100 MHz in LTE Band 28 490 MHz in LTE Band 66 80 MHz in LTE band 71 48 MHz in LTE band 85
Impedance	50Ω
Input Power	33 dBm average
VSWR Absolute Max	≤ 10:1
VSWR Recommended	≤ 2:1

5.1.6 Maximum antenna gain (dBi)

This radio transmitter has been approved by the indicated agency to operate with the maximum permissible gain indicated.

Band	FCC	ISED	RED
GPRS/EGPRS 850	6.90	3.60	-
GPRS/EGPRS 1800			10.34
GPRS/EGPRS 1900	2.50	2.50	-
FDD1	-	-	11.84
FDD 2	8.00	8.00	-
FDD 3	-	-	11.33
FDD 4	5.00	5.00	-
FDD 5	9.40	6.10	-
FDD 8	-	-	8.45
FDD 12	8.60	5.60	-
FDD 13	9.10	5.90	-
FDD 20	-	-	8.20
FDD 25	8.00	8.00	-
FDD 26	9.30	6.00	-
FDD 28	-	-	7.47
FDD 66	5.00	5.00	-
FDD 71	11.40	8.40	-
FDD 85	8.60	5.60	-
FDD 86	9.10		
Omnidirectional	2.14	2.14	2.14

Notes:

FCC - Federal Communications Commission (US)

ISED - Innovation, Science and Economic Development (Canada)

RED - Radio Equipment Directive (Europe)

5.1.7 LTE310SMT GNSS: GPS and GLONASS Antenna Specifications:

Parameter	Description	Note
Input Voltage Range	3.3V	
Frequency Range	1559.0 to 1610.0 MHz	
Gain	15 to 30 dB	
Impedance	50Ω	
VSWR	< 3:1	
Current Consumption	30mA Max, 20mA Typ.	

5 LTE310SMT TECHNICAL SPECIFICATIONS continued

5.2 Mechanical Specifications

5.2.1 LTE310SMT Dimensions

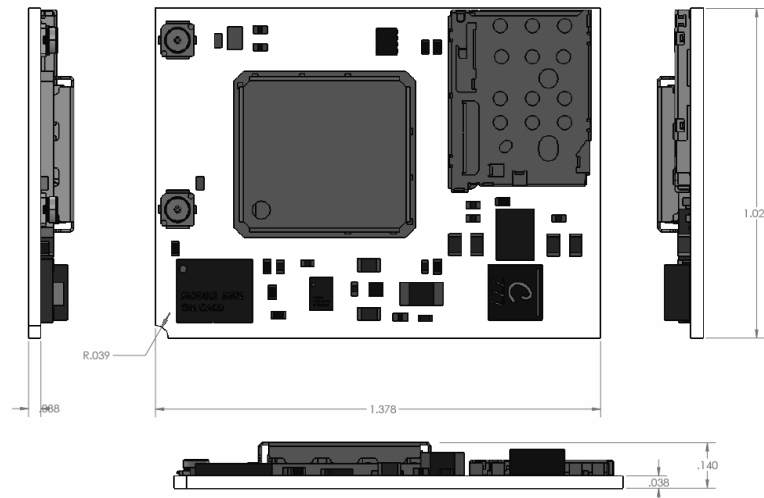
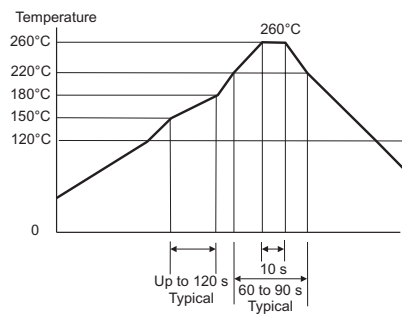

Figure 6 Dimensions Mechanical

5.2.2 Suggested Solder Profile



Meets IPC/JEDEC J-STD-020C

Figure 7 Solder Profile

5.2.3 LTE310SMT Suggested footprint

It is recommended to use a non-solder-mask defined pad implementation.

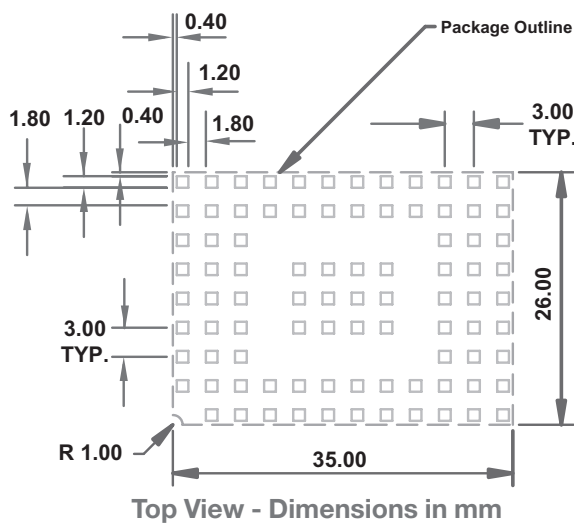

Top View - Dimensions in mm

Figure 8 Footprint Dimensions

5.2.4 LTE310SMT Pad Arrangement

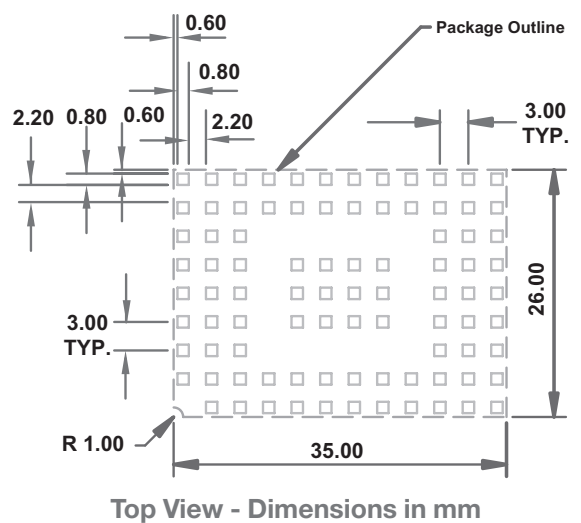

Top View - Dimensions in mm

Figure 9 Package Dimensions

6 Operation

6.1 Powering ON/OFF

6.1.1 Powering ON

Power the Modem ON by pulling the ON_OFF signal (Pad I5) to ground for at least five (5) seconds, then release.

6.1.2 Powering OFF

There are two methods to to turn OFF the Modem under normal circumstances:

- Use the AT shutdown command (AT#SHDN)
- Pull ON_OFF signal (Pin 19) to ground for at least three (3) seconds, then release.

In both instances, power can be removed from the modem once the PWRMON signal goes low.

Under abnormal circumstances, an unconditional shutdown can be performed by holding the ON_OFF signal low for at least 12 seconds.

6.2. Communicating with the Modem

The default configuration of the modem has AT command ports available on the UART interface and the USB interface.

6.2.1 UART Interface

The UART port operates at a the following default parameters:

- Baud Rate: 115.2 kbps
- Bits: 8
- Stop Bits: 1
- Parity: None
- Hardware Handshaking

6.2.2 USB Interface

The USB port instantiates two serial modem connections as AT command ports by default. USB drivers are available from Telit or Janus.

6.3 Testing Communications

- The cellular module should always respond to the attention command with 'OK'. Send:

```
AT<cr>1
```

Note 1. "<cr>" designates a carriage return character.

The module will response with 'OK'.

- Verify the module model. Send:

```
AT+CGMM<cr>
```

The response should be the Telit module model number.

- Verify the firmware version. Send:

```
AT+CGMR<cr>
```

The response will be the Telit module's current firmware.

6 Operation continued

6.4 Cellular Network Communications continued

6.4.3 Signal Strength

Signal channel can be checked as follows. Enter:

```
AT+CSQ<cr>
```

The default response format will contain two numbers:

```
+CSQ: 17,0
```

The first number is the rssi (received signal strength indication) and the second is ber (bit error rate).

The rssi can be interpreted as follows:

10-14 Okay

15-20 Good

20+ Excellent.

Anything below 10 would be considered marginal.

A response of 99 indicates no signal.

6.4.4 Registration

Network registration can be checked as follows. Enter:

```
AT+CEREG?<cr>
```

A response of +CEREG:0,1 or +CEREG: 0,5 indicates the device is registered to the home network or roaming, respectively.

If response is different than this, please refer to the Telit AT command reference document for more information

6.5 Data Communications

The modem incorporates a TCP/IP stack that can be used to directly send data using AT commands. Alternatively, an external host can be used to make a PPP connection.

See the Telit ME910C1/MEx10G1 Quick Start Guide for further information

6.5.1 Data Communications - Using the Internal Stack

To send data using the internal stack, a data context must be activated.

Activate the context as follows:

AT&T centric (FWSWITCH=0):

Enter:

```
AT#SGACT=1,1<cr>
```

Verizon (FWSWITCH=1):

Enter:

```
AT#SGACT=3,1<cr>
```

If successful, the modem will respond with an IP address assigned by the carrier. Data can be sent to a host with a socket dial command. Enter:

```
AT#SD=<connid>,0,80,<IPaddr>
```

where <connid> is the user data context and <IPaddr> is a text string (in quotes) containing a dotted IP address or a DNS resolvable host name.

The modem will respond with CONNECT and any data entered thereafter will be sent to the connected host. Enter the escape sequence:

```
+++
```

to suspend the connection.

See the Telit IP Easy User Guide and the Telit AT Commands Guide for more information.

6 Operation continued

6.5 Data Communications continued

6.5.2 PPP Dialing

In a hosted system (e.g. Linux) the host TCP/IP stack can be used. A PPP connection is initiated using the ATD dialing command. Depending on the script or application performing the PPP connection, you may have to change the numeric digit in the PPP AT dialing command that designates the context to use.

The dialing string for the AT&T centric (#FWSWITCH=0) would be:

```
ATD*99***1#<cr>
```

Where the '1' digit selects the #1 data context set with the +CDGCONT command.

Similarly the dialing string for the Verizon (#FWSWITCH=1) would be:

```
ATD*99***3#<cr>
```

Where the '3' digit selects the #3 data context set with the +CDGCONT command.

6.6 SMS

SMS availability on Cat.M1 networks may be different than what has been experienced on other 4G or 3G network plans. Some may not allow SMS to be sent from a device, or may restrict SMS to operation to other Cat. M1 devices or from portals only. Check with your carrier for specifics.

SMS allows you to send a text message (max 160 characters) to a SMS capable unit.

- Set the SMS mode to text. This setting is not persistent; it must be entered every power cycle.

```
AT+CMGF=1<cr>
```

- To enter the receiving subscriber unit phone number and message enter:

```
AT+CMGS="8885551234"<cr>
```

Wait for response ">" then enter message text .

Enter

```
<ctrl-z>
```

to end the message text and send it.

6.7 GNSS

The GNSS system on the Telit module includes support for stand-alone operation with GPS and GLONASS.

A simple example of stand-alone GPS operation follows.

You must give the GNSS system priority over the WWAN (cellular) system unless you have set the cellular system to operate in PSM (Power Saving Mode). Refer to the Telit MEx10G1 GNSS Application Note for further information.

To set GNSS priority enter:

```
AT$GPSCFG=0,0<cr>
```

and reboot the system:

```
AT#REBOOT<cr>
```

Turn on the GNSS system by entering:

```
AT$GPSP=1<cr>
```

The GNSS antenna bias voltage will also be enabled.

NMEA data can be continuously streamed. For example, enter:

```
AT$GPSNMUN=1,1,1,1,1,1,1,1<cr>
```

Turn them off by entering:

```
AT$GPSNMUN=1,1,1,1,1,1,1,1<cr>
```

6 Operation continued

6.8 Firmware Selection

The LTE310SMT v1.00 uses the Telit module which has firmware to support multiple carriers
The firmware load can be changed by issuing the command:

```
AT#FWSWITCH=<image_number>,1 <cr>
```

where <image_number> is

- 0 for AT&T centric
- 1 for Verizon
- 2 for Worldwide
- 3 for Telstra Australia

The module will automatically reboot with the new firmware image.
Current firmware status can be checked by issuing the command:

```
AT#FWSWITCH? <cr>
```

The response will be #FWSWITCH: <image_number>,n
where <image_number> is as described above.

Note that normally different SIM cards will be required for operation under the different carrier versions.

More information can be found in the Telit Single SKU AT Command Application Note.

7 Design Considerations

7.1 Minimum Required Module Pin Connects

Pin	Signal	Function	Note
D11,D12	VIN	Main power supply	
A8, A11, A12, B3, B11, B12, D5, D6, D7, D8, E1, E5, E6, E7, E8, E12, F5, F6, F7, F8, G10, H3, H7	GND	Ground	
H8	TXD0	Serial data input (TXD) from DTE	
H9	RXD0	Serial data output to DTE	
I8	RTS0	Input for request to send signal (RTS) from DTE	2
I5	ON/OFF	Input command for switching power ON or OFF(toggle command)	
A6	SIMSEL	SIM holder enable	

Note:

1. If the application uses USB as the main interface to the Modem, this is sufficient to capture any debug or trace data, provided the application can export the diagnostic port externally.
2. RTS must be connected to ground if flow control is not used.

7.2 Debug:

It is generally recommended that access to the following signals be available in any final product for debugging support:

- UART (USIF0)
- USB (USB_D_P, USB_D_N, USB_VBUS)
- ON_OFF
- PWRMON
- USB_BOOT

The USB port can be used for flashing full firmware loads onto the module, and can be used by the manufacturer for tracing cellular operation.

An ideal implementation would have an option that allows an external host full control of the USB connection.

APPENDICES

LTE319SMT Approvals

Regulatory Approvals:

PTCRB

FCC

ISED Canada: 5131A-ME310G1WW

CE

Carrier Approval Certifications:

PTCRB

AT&T

Verizon

RED (Radio Equipment Directive for the EU)

Antenna Care and Replacement

Do not use the Modem with a damaged antenna.

Buy the antenna from an approved suppliers list. Using unauthorized antennas, modifications, or attachments could damage the Modem and may violate local RF emission regulations or invalidate type approval.

Abbreviations

3GPP	3rd Generation Partnership Project	HSPA	High Speed Packet Access
AC	Alternating Current	LTE	Long Term Evolution
ADC	Analog To Digital Converter	IoT	Internet of Things
APN	Access Point Name	LED	Light Emitting Diode
BER	Bit Error Rate	M2M	Machine To Machine
CD	Carrier Detect	RF	Radio Frequency
CDMA	Code Division Multiple Access	RI	Ring Indicator
CTS	Clear To Send	RSSI	Received Signal Strength Indication
DB	Decibel	RTS	Request To Send
DC	Direct Current	RxD	Received Data
DCE	Data Communications Equipment	SMS	Short Message Service
DSR	Data Set Ready	TTFF	Time To First Fix
DTMF	Dual-tone multi-frequency	TxD	Transmitted Data
DTR	DTE Ready	UICC	Universal Integrated Circuit Card
GNSS	Global Navigation Satellite System	UMTS	Universal Mobile Telecommunications System
GPIO	General Purpose Input Output	USIM	Universal Subscriber Identity Module
GPRS	General Packet Radio Service	VSWR	Voltage Standing Wave Ratio
GSM	Global System Mobile	WCDMA	Wideband Code Division Multiplexing Access

LTE310SMT v1.00 CAT-M1/NB2 Global 4G Cellular Modem Manual

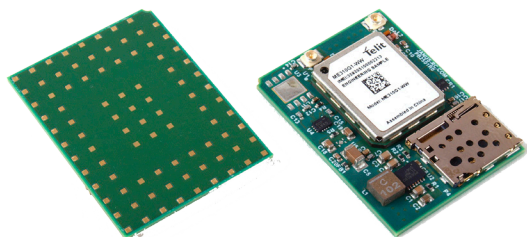

Ordering Information

Ordering Information	Description
LTE310SMT v1.00	LTE Cat-M1/NB-IOT Modem - GNSS Enabled - AT&T, Verizon, Worldwide

Revision History

Revision	Revision Date	Note
00	10/22/20	LTE310SMT v1.00 CAT-M1/NB-IOT User Manual release
01	08/05/21	Updated S_LED output signal information
02	01/19/22	Updated Regulatory Approvals and Carrier Certifications
03	03/07/23	Update for Interfaces, Technical Specifications and Design Consideration-Debug



Division of The Connor-Winfield Corporation

2359 Diehl Road • Aurora, IL 60502

Phone: 630.499.2121 • info@janus-rc.com

www.janus-rc.com